



Dell™ Vostro™ 1500 and Inspiron™ 1520/1521 Service Manual

[Before You Begin](#)
[ExpressCards](#)
[Using the Memory Card Reader](#)
[Optical Drive](#)
[Hard Drive](#)
[Hinge Cover](#)
[Internal Card With Bluetooth® Wireless Technology](#)
[Keyboard](#)
[Memory](#)
[Display](#)
[Palm Rest](#)
[Wireless Mini Cards](#)

[Modem](#)
[Coin-Cell Battery](#)
[Graphics Card Assembly](#)
[Processor Thermal-Cooling Assembly](#)
[Processor Module](#)
[Fan](#)
[Speaker Assembly](#)
[System Board Assembly](#)
[Computer Base and Components](#)
[Battery Latch Assembly](#)
[Flashing the BIOS](#)
[Pin Assignments for I/O Connectors](#)

Model PP22L

Notes, Notices, and Cautions

-  **NOTE:** A NOTE indicates important information that helps you make better use of your computer.
 -  **NOTICE:** A NOTICE indicates either potential damage to hardware or loss of data and tells you how to avoid the problem.
 -  **CAUTION:** A CAUTION indicates potential for property damage, personal injury, or death.
-

Information in this document is subject to change without notice.
© 2007 Dell Inc. All rights reserved.

Reproduction in any manner whatsoever without the written permission of Dell Inc. is strictly forbidden.

Trademarks used in this text: *Dell*, the *DELL* logo, *Inspiron*, and *Vostro* are trademarks of Dell Inc.; *Microsoft*, *Windows*, and *Windows Vista* are either trademarks or registered trademarks of Microsoft Corporation in the United States and/or other countries.

Other trademarks and trade names may be used in this document to refer to either the entities claiming the marks and names or their products. Dell Inc. disclaims any proprietary interest in trademarks and trade names other than its own.

June 2007 Rev. A00

Computer Base and Components

Dell™ Vostro™ 1500 and Inspiron™ 1520/1521 Service Manual

- [Wireless Sniffer Board](#)
 - [Audio Connector Board](#)
 - [Consumer Infrared \(CIR\) Board](#)
 - [Modem Connector](#)
 - [ExpressCard Cage](#)
 - [Computer Base](#)
-

Wireless Sniffer Board

Removing the Wireless Sniffer Board

⚠ CAUTION: Before you begin the following procedure, follow the safety instructions in the *Product Information Guide*.

1. Follow the instructions in [Before You Begin](#).
2. Remove the optical drive (see [Removing the Optical Drive](#)).
3. Remove the hard drive (see [Removing the Hard Drive](#)).
4. Remove the hinge cover (see [Removing the Hinge Cover](#)).
5. Remove the keyboard (see [Removing the Keyboard](#)).
6. Remove the display assembly (see [Removing the Display Assembly](#)).
7. Remove the internal card with Bluetooth wireless technology, if installed (see [Removing the Bluetooth Card](#)).
8. Remove the palm rest (see [Removing the Palm Rest](#)).
9. Remove the M2 x3-mm screw that secures the wireless sniffer board to the base of the computer.
10. Lift the wireless sniffer board out of the computer.

👉 NOTICE: Do not disconnect the sniffer cable from the system board.

11. Disconnect the sniffer cable from the wireless sniffer board.

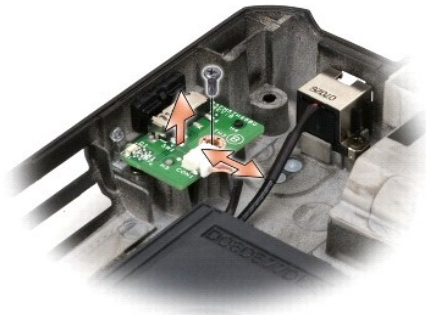

Replacing the Wireless Sniffer Board

 **CAUTION:** Before you begin the following procedure, follow the safety instructions in the *Product Information Guide*.

1. Connect the sniffer cable to the wireless sniffer board.
 2. Align the screw hole in the wireless sniffer board with the screw hole in the base of the computer, and then lower the board into place.
 3. Replace the M2 x 3-mm screw and secure the wireless sniffer board to the base of the computer.
 4. Replace the palm rest (see [Replacing the Palm Rest](#)).
 5. Replace the internal card with Bluetooth wireless technology, if installed (see [Replacing the Bluetooth Card](#)).
 6. Replace the display assembly (see [Replacing the Display Assembly](#)).
 7. Replace the keyboard (see [Replacing the Keyboard](#)).
 8. Replace the hinge cover (see [Replacing the Hinge Cover](#)).
 9. Replace the hard drive (see [Replacing the Hard Drive](#)).
 10. Replace the optical drive (see [Replacing the Optical Drive](#)).
-

Audio Connector Board

Removing the Audio Connector Board

 **CAUTION:** Before you begin the following procedure, follow the safety instructions in the *Product Information Guide*.

1. Follow the instructions in [Before You Begin](#).
2. Remove the optical drive (see [Removing the Optical Drive](#)).
3. Remove the hard drive (see [Removing the Hard Drive](#)).
4. Remove the hinge cover (see [Removing the Hinge Cover](#)).
5. Remove the keyboard (see [Removing the Keyboard](#)).
6. Remove the display assembly (see [Removing the Display Assembly](#)).
7. Remove the internal card with Bluetooth wireless technology, if installed (see [Removing the Bluetooth Card](#)).
8. Remove the palm rest (see [Removing the Palm Rest](#)).
9. Remove the M2.5 x 5-mm screw that secures the audio connector board to the base of the computer.
10. Lift the audio connector board out of the computer.

 **NOTICE:** Do not disconnect the audio cable from the system board.

11. Disconnect the audio cable from the audio connector board.



Replacing the Audio Connector Board

⚠ CAUTION: Before you begin the following procedure, follow the safety instructions in the *Product Information Guide*.

1. Connect the audio cable to the audio connector board.
 2. Align the screw hole in the audio connector board with the screw hole in the base of the computer, and then lower the board into place.
 3. Replace the M2.5 x 5-mm screw and secure the audio connector board to the base of the computer.
 4. Replace the palm rest (see [Replacing the Palm Rest](#)).
 5. Replace the internal card with Bluetooth wireless technology, if installed (see [Replacing the Bluetooth Card](#)).
 6. Replace the display assembly (see [Replacing the Display Assembly](#)).
 7. Replace the keyboard (see [Replacing the Keyboard](#)).
 8. Replace the hinge cover (see [Replacing the Hinge Cover](#)).
 9. Replace the hard drive (see [Replacing the Hard Drive](#)).
 10. Replace the optical drive (see [Replacing the Optical Drive](#)).
-

Consumer Infrared (CIR) Board

Removing the CIR Board

⚠ CAUTION: Before you begin the following procedure, follow the safety instructions in the *Product Information Guide*.

1. Follow the instructions in [Before You Begin](#).
2. Remove the optical drive (see [Removing the Optical Drive](#)).
3. Remove the hard drive (see [Removing the Hard Drive](#)).
4. Remove the hinge cover (see [Removing the Hinge Cover](#)).
5. Remove the keyboard (see [Removing the Keyboard](#)).
6. Remove the display assembly (see [Removing the Display Assembly](#)).
7. Remove the internal card with Bluetooth wireless technology, if installed (see [Removing the Bluetooth Card](#)).

8. Remove the palm rest (see [Removing the Palm Rest](#)).
9. Remove the M2.5 x 5-mm screw that secures the CIR board to the base of the computer.
10. Lift the CIR board out of the computer.

 **NOTICE:** Do not disconnect the CIR cable from the system board.

11. Disconnect the CIR cable from the CIR board.



Replacing the CIR Board

 **CAUTION:** Before you begin the following procedure, follow the safety instructions in the *Product Information Guide*.

1. Connect the CIR cable to the CIR board.
2. Align the screw hole in the CIR board with the screw hole in the base of the computer, and then lower the board into place.
3. Replace the M2.5 x 5-mm screw and secure the CIR board to the base of the computer.
4. Replace the palm rest (see [Replacing the Palm Rest](#)).
5. Replace the internal card with Bluetooth wireless technology, if installed (see [Replacing the Bluetooth Card](#)).
6. Replace the display assembly (see [Replacing the Display Assembly](#)).
7. Replace the keyboard (see [Replacing the Keyboard](#)).
8. Replace the hinge cover (see [Replacing the Hinge Cover](#)).
9. Replace the hard drive (see [Replacing the Hard Drive](#)).
10. Replace the optical drive (see [Replacing the Optical Drive](#)).

Modem Connector

Removing the Modem Connector

 **CAUTION:** Before you begin the following procedure, follow the safety instructions in the *Product Information Guide*.

1. Follow the instructions in [Before You Begin](#).
2. Remove the optical drive (see [Removing the Optical Drive](#)).
3. Remove the hard drive (see [Removing the Hard Drive](#)).

4. Remove the hinge cover (see [Removing the Hinge Cover](#)).
5. Remove the keyboard (see [Removing the Keyboard](#)).
6. Remove the display assembly (see [Removing the Display Assembly](#)).
7. Remove the internal card with Bluetooth wireless technology, if installed (see [Removing the Bluetooth Card](#)).
8. Remove the palm rest (see [Removing the Palm Rest](#)).
9. Disconnect the modem connector cable from the modem.
10. Remove the M2.5 x 5-mm screw that secures the modem connector to the base of the computer.

➡ **NOTICE:** Before you remove the modem connector, observe how the cable is routed on the base of the computer to ensure proper installation when the connector is replaced.

11. Lift the modem connector out of the computer.

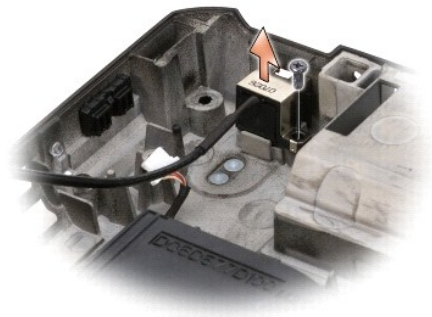

Replacing the Modem Connector

⚠ **CAUTION:** Before you begin the following procedure, follow the safety instructions in the *Product Information Guide*.

1. Align the screw hole in the modem connector with the screw hole in the base of the computer, and then lower the connector into place.
2. Replace the M2.5 x 5-mm screw and secure the modem connector to the base of the computer.

➡ **NOTICE:** Ensure that the modem connector cable is properly routed before connecting the cable to the modem.

3. Connect the modem connector cable to the modem.
4. Replace the palm rest (see [Replacing the Palm Rest](#)).
5. Replace the internal card with Bluetooth wireless technology, if applicable (see [Replacing the Bluetooth Card](#)).
6. Replace the display assembly (see [Replacing the Display Assembly](#)).
7. Replace the keyboard (see [Replacing the Keyboard](#)).
8. Replace the hinge cover (see [Replacing the Hinge Cover](#)).
9. Replace the hard drive (see [Replacing the Hard Drive](#)).
10. Replace the optical drive (see [Replacing the Optical Drive](#)).

ExpressCard Cage

Removing the ExpressCard Cage

⚠ CAUTION: Before you begin the following procedure, follow the safety instructions in the *Product Information Guide*.

1. Follow the instructions in [Before You Begin](#).
2. Remove the optical drive (see [Removing the Optical Drive](#)).
3. Remove the hard drive (see [Removing the Hard Drive](#)).
4. Remove the hinge cover (see [Removing the Hinge Cover](#)).
5. Remove the keyboard (see [Removing the Keyboard](#)).
6. Remove the display assembly (see [Removing the Display Assembly](#)).
7. Remove the internal card with Bluetooth wireless technology, if installed (see [Removing the Bluetooth Card](#)).
8. Remove the palm rest (see [Removing the Palm Rest](#)).
9. Remove the four M2.5 x 5-mm screws that secure the ExpressCard cage to the base of the computer.
10. Carefully lift the ExpressCard cage out of the computer.

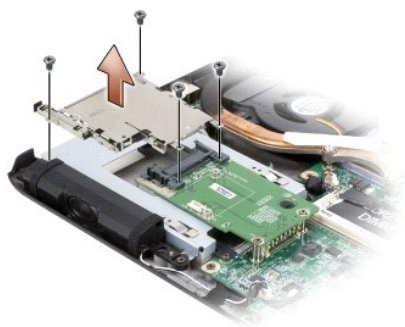

Replacing the ExpressCard Cage

⚠ CAUTION: Before you begin the following procedure, follow the safety instructions in the *Product Information Guide*.

1. Align the screw holes on the ExpressCard cage with the screw holes on the base of the computer, then lower the ExpressCard cage into place.
2. Replace the four M2.5 x 5-mm screws and secure the ExpressCard cage to the base of the computer.
3. Replace the palm rest (see [Replacing the Palm Rest](#)).
4. Replace the internal card with Bluetooth wireless technology, if applicable (see [Replacing the Bluetooth Card](#)).
5. Replace the display assembly (see [Replacing the Display Assembly](#)).
6. Replace the keyboard (see [Replacing the Keyboard](#)).
7. Replace the hinge cover (see [Replacing the Hinge Cover](#)).
8. Replace the hard drive (see [Replacing the Hard Drive](#)).

9. Replace the optical drive (see [Replacing the Optical Drive](#)).
-

Computer Base

Removing the Computer Base

⚠ CAUTION: Before you begin the following procedure, follow the safety instructions in the *Product Information Guide*.

1. Follow the instructions in [Before You Begin](#).
2. Remove the system board (see [Removing the System Board Assembly](#)).

🔧 NOTE: When removing the system board to replace the computer base, it is not necessary to remove the processor, memory, or Mini-Card.

3. Remove the wireless sniffer board (see [Removing the Wireless Sniffer Board](#)).
4. Remove the audio connector board (see [Removing the Audio Connector Board](#)).
5. Remove the CIR board (see [Removing the CIR Board](#)).
6. Remove the speaker assembly (see [Removing the Speaker Assembly](#)).

Replacing the Computer Base

⚠ CAUTION: Before you begin the following procedure, follow the safety instructions in the *Product Information Guide*.

1. Replace the speaker assembly (see [Replacing the Speaker Assembly](#)).
2. Replace the CIR board (see [Replacing the CIR Board](#)).
3. Replace the audio connector board (see [Replacing the Audio Connector Board](#)).
4. Replace the wireless sniffer board (see [Replacing the Wireless Sniffer Board](#)).

➡ NOTICE: Ensure that the rubber gasket is installed in the appropriate location for your processor. The gasket can be moved as needed.

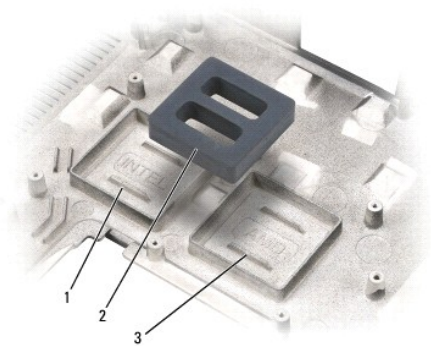

1	location for Intel processor	2	rubber gasket
3	location for AMD processor		

5. Complete the replacement of the computer base by following the procedures in [Replacing the System Board Assembly](#).
-

[Back to Contents Page](#)

[Back to Contents Page](#)

Before You Begin

Dell™ Vostro™ 1500 and Inspiron™ 1520/1521 Service Manual

- [Recommended Tools](#)
- [Before Working Inside Your Computer](#)

This document provides procedures for removing and installing the components in your computer. Unless otherwise noted, each procedure assumes that:

- 1 You have performed the steps in [Before Working Inside Your Computer](#).
- 1 You have read the safety information in your Dell *Product Information Guide*.
- 1 When replacing a component, you have already removed the original, if installed.

 **NOTE:** The color of your system and certain system components may appear differently than shown in this document.

Recommended Tools

The procedures in this document may require the following tools:



- 1 Small flat-blade screwdriver
 - 1 Phillips screwdriver
 - 1 Small plastic scribe
 - 1 Flash BIOS update (see the Dell Support website at support.dell.com)
-

Before Working Inside Your Computer

Use the following safety guidelines to help protect your computer from potential damage and to help ensure your own personal safety.

 **CAUTION:** Before you begin any of the procedures in this section, follow the safety instructions in the *Product Information Guide*.

- ➔ **NOTICE:** Only a certified service technician should perform repairs on your computer. Damage due to servicing that is not authorized by Dell is not covered by your warranty.
- ➔ **NOTICE:** To avoid electrostatic discharge, ground yourself by using a wrist grounding strap or by periodically touching an unpainted metal surface, such as a connector on the back of the computer.
- ➔ **NOTICE:** Handle components and cards with care. Do not touch the components or contacts on a card. Hold a card by its edges or by its metal mounting bracket. Hold a component such as a processor by its edges, not by its pins.
- ➔ **NOTICE:** When disconnecting a cable, pull on the cable's connector or on its strain-relief loop, not on the cable itself. For cable connectors with locking tabs, press inward on the locking tabs to release the connector. When connecting a cable, ensure that the connectors are correctly oriented and aligned to avoid damage to the connector and/or the connector's pins.

1. Ensure that the work surface is flat and clean to prevent the computer cover from being scratched.
2. Click **Start** , click the arrow  icon, and then click **Shut Down** to turn off your computer.

 **NOTE:** Ensure that the computer is off and not in a power management mode. If you cannot shut down the computer using the operating system, press and hold the power button for 4 seconds.

3. Disconnect your computer and all attached devices from their electrical outlets.

➔ **NOTICE:** To disconnect a network cable, first unplug the cable from your computer, and then unplug it from the network wall jack.

4. Disconnect any telephone or network cables from the computer.

5. Remove any installed cards from the ExpressCard slot (see [Removing an ExpressCard or Blank](#)) and the 8-in-1 memory card reader (see [Removing a Memory Card or Blank](#)).

➔ **NOTICE:** To help prevent damage to the system board, you must remove the battery from the battery bay before you service the computer.

 **NOTE:** To avoid damage to the computer, use only the battery designed for this particular Dell computer. Do not use batteries designed for other Dell computers.

6. Turn the computer over.

7. Slide the battery release latches until they click into place.

8. Slide the battery out of the battery bay.

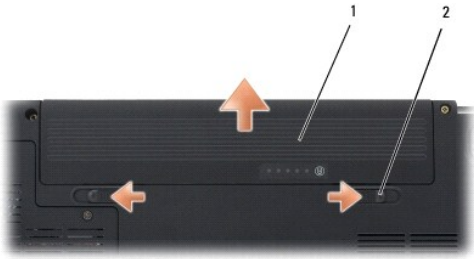

1	battery	2	battery release latch (2)
---	---------	---	---------------------------

9. Turn the computer top-side up, open the display, and press the power button to ground the system board.

[Back to Contents Page](#)

Flashing the BIOS

Dell™ Vostro™ 1500 and Inspiron™ 1520/1521 Service Manual

- [Flashing the BIOS From a CD](#)
- [Flashing the BIOS From the Hard Drive](#)

If a BIOS-update program CD is provided with a new system board, flash the BIOS from the CD. If you do not have a BIOS-update program CD, flash the BIOS from the hard drive.

Flashing the BIOS From a CD

➡ **NOTICE:** Plug the AC adapter into a known good power source to prevent a loss of power. Failure to do so may cause system damage.

1. Ensure that the AC adapter is plugged in and that the main battery is installed properly.

📌 **NOTE:** If you use a BIOS update program CD to flash the BIOS, press <F12> before inserting the CD so that you can set up the computer to boot from a CD for one time only. Otherwise, you must enter the system setup program to change the default boot order.

2. Insert the BIOS-update program CD, and turn on the computer.

➡ **NOTICE:** Do not interrupt this process once it begins. Doing so may cause system damage.

Follow the instructions that appear on the screen. The computer continues to boot and updates the new BIOS. When the flash update is complete, the computer will automatically reboot.

3. Press <F2> during POST to enter the system setup program.
 4. Press <Alt> and <F> to reset the computer defaults.
 5. Press <Esc>, select **Save/Exit**, and press <Enter> to save configuration changes.
 6. Remove the flash BIOS update program CD from the drive and restart the computer.
-

Flashing the BIOS From the Hard Drive

➡ **NOTICE:** Plug the AC adapter into a known good power source to prevent a loss of power. Failure to do so may cause system damage.

1. Ensure that the AC adapter is plugged in, the main battery is properly installed, and a network cable is attached.
2. Turn on the computer.
3. Locate the latest BIOS update file for your computer at support.dell.com.

4. Click **Download Now** to download the file.

5. If the **Export Compliance Disclaimer** window appears, click **Yes, I Accept this Agreement**.

The **File Download** window appears.

6. Click **Save this program to disk**, and then click **OK**.

The **Save In** window appears.

7. Click the down arrow to view the **Save In** menu, select **Desktop**, and then click **Save**.

The file downloads to your desktop.

8. Click **Close** if the **Download Complete** window appears.

The file icon appears on your desktop and is titled the same as the downloaded BIOS update file.

9. Double-click the file icon on the desktop and follow the instructions on the screen.

[Back to Contents Page](#)

[Back to Contents Page](#)

Internal Card With Bluetooth® Wireless Technology

Dell™ Vostro™ 1500 and Inspiron™ 1520/1521 Service Manual

- [Removing the Bluetooth Card](#)
- [Replacing the Bluetooth Card](#)

⚠ CAUTION: Before you begin any of the procedures in this section, follow the safety instructions in the *Product Information Guide*.

If you ordered a card with Bluetooth wireless technology with your computer, it is already installed.

Removing the Bluetooth Card

1. Follow the procedures in [Before You Begin](#).
2. Remove the hinge cover (see [Removing the Hinge Cover](#)).
3. Disconnect the cable on the card.
4. Grasp the connector end of the card and slide it out from under the securing tabs.



1	securing tab	2	card
3	securing tab	4	cable

Replacing the Bluetooth Card

⚠ CAUTION: Before you begin any of the procedures in this section, follow the safety instructions in the *Product Information Guide*.

1. Follow the procedures in [Before You Begin](#).
 2. Replace the card at an angle to slide it under the securing tabs in the card compartment.
 3. Connect the cable to the card.
 4. Replace the hinge cover (see [Replacing the Hinge Cover](#)).
-

[Back to Contents Page](#)

[Back to Contents Page](#)

Using the Memory Card Reader

Dell™ Vostro™ 1500 and Inspiron™ 1520/1521 Service Manual

- [Memory Card Blanks](#)
- [Removing a Memory Card or Blank](#)
- [Installing a Memory Card](#)

The memory card reader provides a fast and convenient way to view and share digital photos, music, and videos stored on a memory card.

 **NOTE:** A memory card is not a bootable device.

The 8-in-1 memory card reader reads the following memory cards:

- 1 Secure Digital (SD)
- 1 SDIO
- 1 MultiMediaCard (MMC)
- 1 Memory Stick
- 1 Memory Stick PRO
- 1 xD-Picture Card
- 1 Hi Speed-SD
- 1 Hi Density-SD



Memory Card Blanks

Your computer shipped with a plastic blank installed in the 8-in-1 memory card reader. Blanks protect unused slots from dust and other particles. Save the blank for use when no memory card is installed in the slot.

 **NOTE:** Blanks from other computers may not fit your computer.

Removing a Memory Card or Blank

 **CAUTION:** Before you begin any of the procedures in this section, follow the safety instructions in the *Product Information Guide*.

 **NOTICE:** Use the memory card configuration utility (click the  icon in the notification area) to select a card and stop it from functioning before you remove it from the computer. If you do not stop the card in the configuration utility, you may lose data.

Press the card into the slot to release it from the card reader. When it is partially ejected, remove the card.

Installing a Memory Card

 **CAUTION:** Before you begin any of the procedures in this section, follow the safety instructions in the *Product Information Guide*.

You can install a memory card in the computer while the computer is running. The computer automatically detects the card.

Memory cards are generally marked with a symbol (such as a triangle or an arrow) or a label to indicate which end to insert into the slot. The cards are keyed to prevent incorrect insertion. If card orientation is not clear, see the documentation that came with the card.

1. Hold the card with the top side of the card facing up.
2. Slide the card into the slot until the card is completely seated in its connector.

If you encounter too much resistance, do not force the card. Check the card orientation and try again.



The computer recognizes the memory card and automatically loads the appropriate device driver. If the configuration program tells you to load the manufacturer's drivers, use the media that came with the memory card, if applicable.

[Back to Contents Page](#)

Coin-Cell Battery

Dell™ Vostro™ 1500 and Inspiron™ 1520/1521 Service Manual

- [Removing the Coin-Cell Battery](#)
- [Replacing the Coin-Cell Battery](#)

Removing the Coin-Cell Battery

⚠ CAUTION: Before you begin any of the procedures in this section, follow the safety instructions in the *Product Information Guide*.

1. Follow the procedures in [Before You Begin](#).
2. Turn the computer over.
3. Loosen the captive screw on the memory module cover, then remove the cover and set it aside.

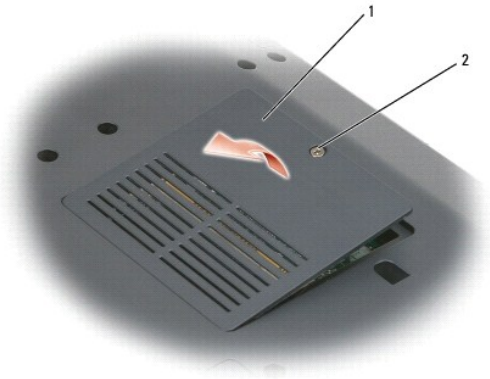

1	memory module cover	2	captive screw
---	---------------------	---	---------------

4. Disconnect the coin-cell battery cable from the system board.
5. Slide the battery out of the mylar sleeve.

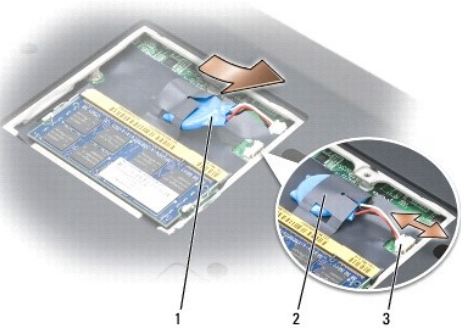

1	coin-cell battery	2	mylar sleeve
3	battery cable connector		

Replacing the Coin-Cell Battery

 **CAUTION:** Before you begin any of the procedures in this section, follow the safety instructions in the *Product Information Guide*.

1. Follow the procedures in [Before You Begin](#).
2. Connect the coin-cell battery cable to the system board.
3. Slide the coin-cell battery into the mylar sleeve.
4. Replace the memory module cover and tighten the captive screw.

[Back to Contents Page](#)

Processor Module

Dell™ Vostro™ 1500 and Inspiron™ 1520/1521 Service Manual

- [Removing the Processor Module](#)
- [Replacing the Processor Module](#)

Removing the Processor Module

⚠ CAUTION: Before you begin the following procedure, follow the safety instructions in the *Product Information Guide*.

1. Follow the instructions in [Before You Begin](#).
2. Remove the optical drive (see [Removing the Optical Drive](#)).
3. Remove the hard drive (see [Removing the Hard Drive](#)).
4. Remove the hinge cover (see [Removing the Hinge Cover](#)).
5. Remove the keyboard (see [Removing the Keyboard](#)).
6. Remove the display assembly (see [Removing the Display Assembly](#)).
7. Remove the internal card with Bluetooth wireless technology, if installed (see [Removing the Bluetooth Card](#)).
8. Remove the palm rest (see [Removing the Palm Rest](#)).
9. Remove the processor thermal-cooling assembly (see [Removing the Processor Thermal-Cooling Assembly](#)).

➡ NOTICE: To avoid damage to the processor, hold the screwdriver so that it is perpendicular to the processor when turning the cam screw.

10. To loosen the ZIF socket, use a small, flat-blade screwdriver and rotate the ZIF-socket cam screw counterclockwise until it comes to the cam stop.



1	ZIF-socket cam screw	2	ZIF socket
---	----------------------	---	------------

➡ NOTICE: To ensure maximum cooling for the processor, do not touch the heat transfer areas on the processor thermal-cooling assembly. The oils in your skin can reduce the heat transfer capability of the thermal pads.

➡ NOTICE: When removing the processor module, pull the module straight up. Be careful not to bend the pins on the processor module.

11. Lift the processor module from the ZIF socket.
-

Replacing the Processor Module

⚠ CAUTION: Before you begin the following procedure, follow the safety instructions in the *Product Information Guide*.

➡ NOTICE: Do not touch the processor die. Press and hold the processor down on the substrate on which the die is mounted while turning the cam screw to prevent intermittent contact between the cam screw and processor.

➡ NOTICE: Ensure that the cam lock is in the fully open position before seating the processor module. Seating the processor module properly in the ZIF socket does not require force. A processor module that is not properly seated can result in an intermittent connection or permanent damage to the microprocessor and ZIF socket.

🔍 NOTE: If a new processor is installed, you will receive a new thermal-cooling assembly, which will include an affixed thermal pad, or you will receive a new thermal pad along with a tech sheet to illustrate proper installation.

1. Align the pin-1 corner of the processor module with the pin-1 corner of the ZIF socket, then insert the processor module.

🔍 NOTE: The pin-1 corner of the processor module has a triangle that aligns with the triangle on the pin-1 corner of the ZIF socket.

When the processor module is properly seated, all four corners are aligned at the same height. If one or more corners of the module are higher than the others, the module is not seated properly.



1	ZIF-socket cam screw	2	ZIF socket
3	pin-1 corner		

➡ NOTICE: To avoid damage to the processor, hold the screwdriver so that it is perpendicular to the processor when turning the cam screw.

2. Tighten the ZIF socket by turning the cam screw clockwise to secure the processor module to the system board.
3. Replace the processor thermal-cooling assembly (see [Replacing the Processor Thermal-Cooling Assembly](#)).
4. Replace the palm rest (see [Replacing the Palm Rest](#)).
5. Replace the internal card with Bluetooth wireless technology, if applicable (see [Replacing the Bluetooth Card](#)).
6. Replace the display assembly (see [Replacing the Display Assembly](#)).
7. Replace the keyboard (see [Replacing the Keyboard](#)).
8. Replace the hinge cover (see [Replacing the Hinge Cover](#)).
9. Replace the hard drive (see [Replacing the Hard Drive](#)).
10. Replace the optical drive (see [Replacing the Optical Drive](#)).

Processor Thermal-Cooling Assembly

Dell™ Vostro™ 1500 and Inspiron™ 1520/1521 Service Manual

- [Removing the Processor Thermal-Cooling Assembly](#)
- [Replacing the Processor Thermal-Cooling Assembly](#)

Removing the Processor Thermal-Cooling Assembly

⚠ CAUTION: Before you begin the following procedure, follow the safety instructions in the *Product Information Guide*.

1. Follow the instructions in [Before You Begin](#).
2. Remove the optical drive (see [Removing the Optical Drive](#)).
3. Remove the hard drive (see [Removing the Hard Drive](#)).
4. Remove the hinge cover (see [Removing the Hinge Cover](#)).
5. Remove the keyboard (see [Removing the Keyboard](#)).
6. Remove the display assembly (see [Removing the Display Assembly](#)).
7. Remove the internal card with Bluetooth wireless technology, if installed (see [Removing the Bluetooth Card](#)).
8. Remove the palm rest (see [Removing the Palm Rest](#)).
9. In sequential order, loosen the four captive screws that secure the processor thermal-cooling assembly to the system board, then carefully lift the processor thermal-cooling assembly out of the computer.

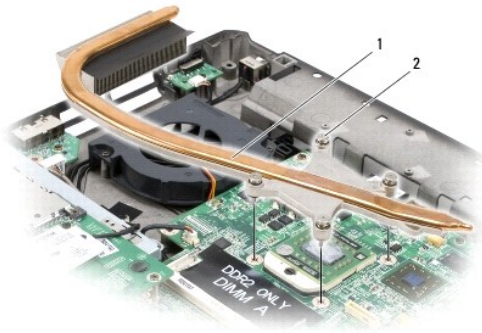

1	processor thermal-cooling assembly	2	captive screws (4)
---	------------------------------------	---	--------------------

Replacing the Processor Thermal-Cooling Assembly

⚠ CAUTION: Before you begin the following procedure, follow the safety instructions in the *Product Information Guide*.

1. Align the four captive screws on the processor thermal-cooling assembly with the screw holes on the system board.
2. In sequential order, tighten the four captive screws to secure the processor thermal-cooling assembly to the system board.
3. Replace the palm rest (see [Replacing the Palm Rest](#)).
4. Replace the internal card with Bluetooth wireless technology, if applicable (see [Replacing the Bluetooth Card](#)).

5. Replace the display assembly (see [Replacing the Display Assembly](#)).
 6. Replace the keyboard (see [Replacing the Keyboard](#)).
 7. Replace the hinge cover (see [Replacing the Hinge Cover](#)).
 8. Replace the hard drive (see [Replacing the Hard Drive](#)).
 9. Replace the optical drive (see [Replacing the Optical Drive](#)).
-

[Back to Contents Page](#)

Display

Dell™ Vostro™ 1500 and Inspiron™ 1520/1521 Service Manual

- [Display Assembly](#)
 - [Display Bezel](#)
 - [Display Panel](#)
 - [Display Latch](#)
 - [Camera and Microphone Assembly](#)
-

Display Assembly

Removing the Display Assembly

⚠ CAUTION: Before you begin the following procedure, follow the safety instructions in the *Product Information Guide*.

1. Follow the instructions in [Before You Begin](#).
2. Close the display and turn the computer over.
3. Loosen the two captive screws that secure the Mini Card compartment cover, then remove the cover and set it aside.
4. Disconnect antenna cables from any installed Mini Cards (see [Wireless Mini Cards](#)).
5. Remove the two M2.5 x 8-mm screws from the bottom of the computer.



6. Remove the two M2.5 x 8-mm screws from the back of the computer.



7. Remove the hinge cover (see [Removing the Hinge Cover](#)).
 8. Remove the keyboard (see [Removing the Keyboard](#)).
 9. Loosen the captive grounding screw, then disconnect the display cable from the display cable connector on the system board.
 10. Disconnect the camera/microphone cable from the camera/microphone cable connector on the system board.
 11. Lift the display cable and antenna cables from beneath the tabs on the palm rest.
- 👉 NOTICE:** Ensure that the display cable and the antenna cables do not get caught beneath the plastic tabs on the palm rest.
12. Lift the display assembly out of the computer.

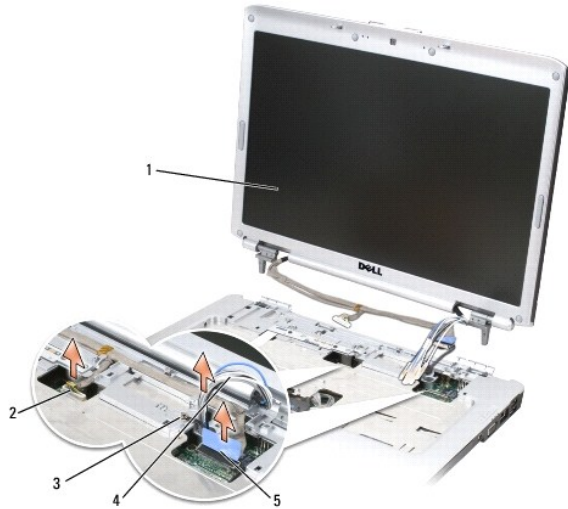

1	display assembly	2	camera/microphone cable
3	grounding screw	4	antenna cables
5	display cable		

Replacing the Display Assembly

⚠ CAUTION: Before you begin the following procedure, follow the safety instructions in the *Product Information Guide*.

1. Follow the instructions in [Before You Begin](#).
2. Align the display hinges with the holes in the base of the computer, then lower the display into place.
3. Slide the antenna cables through the hole in the palm rest and the base of the computer.

➡ NOTICE: Ensure that the display cable and antenna cables are properly routed and secured beneath the plastic tabs on the palm rest.

4. Route the display cable and antenna cables beneath the plastic tabs on the palm rest.
5. Connect the camera/microphone cable to the camera/microphone cable connector on the system board.
6. Connect the display cable to the display cable connector on the system board.
7. Replace and tighten the captive grounding screw.
8. Replace the keyboard (see [Replacing the Keyboard](#)).
9. Replace the hinge cover (see [Replacing the Hinge Cover](#)).
10. Replace the two M2.5 x 8-mm screws on the back of the computer.



11. Close the display and turn the computer over.
12. Replace the two M2.5 x 8-mm screws on the bottom of the computer.



13. Connect the Mini-Card antenna cables (see [Wireless Mini Cards](#)).
14. Replace the Mini Card compartment cover and tighten the screws.

Display Bezel

Removing the Display Bezel

⚠ CAUTION: Before you begin the following procedure, follow the safety instructions in the *Product Information Guide*.

1. Follow the instructions in [Before You Begin](#).
2. Remove the hinge cover (see [Removing the Hinge Cover](#)).
3. Remove the keyboard (see [Removing the Keyboard](#)).
4. Remove the display assembly (see [Removing the Display Assembly](#)).
5. Remove the four rubber display bumpers and two mylar screw covers from around the display bezel.
6. Remove the six M2.5 x 4.2-mm shoulder screws from around the display bezel.

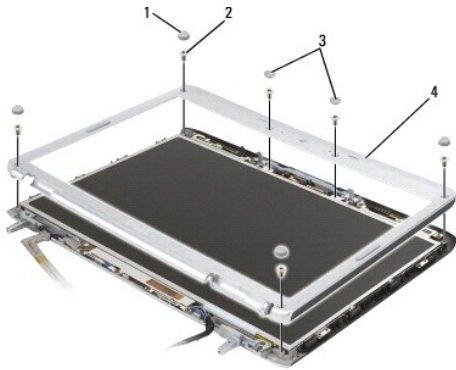

1	rubber display bumpers (4)	2	M2.5 x 4.2-mm screws (6)
3	mylar screw covers (2)	4	display bezel

👉 NOTICE: Removal of the bezel from the display back cover requires extreme care to avoid damage to the bezel.

7. Starting at the top corner of the display panel, use your fingers to separate the bezel from the top cover, then lift the inside edges to separate the remainder of the bezel.

Replacing the Display Bezel

⚠ CAUTION: Before you begin the following procedure, follow the safety instructions in the *Product Information Guide*.

1. Follow the instructions in [Before You Begin](#).

2. Starting at any corner, use your fingers to gently snap the bezel into place to secure it to the display panel.
3. Replace the six M2.5 x 4.2-mm shoulder screws around the display bezel.
4. Replace the four rubber display bumpers and two mylar screw covers around the display bezel.
5. Replace the display assembly (see [Replacing the Display Assembly](#)).
6. Replace the keyboard (see [Replacing the Keyboard](#)).
7. Replace the hinge cover (see [Replacing the Hinge Cover](#)).

Display Panel

Removing the Display Panel

⚠ CAUTION: Before you begin the following procedure, follow the safety instructions in the *Product Information Guide*.

1. Follow the instructions in [Before You Begin](#).
2. Remove the hinge cover (see [Removing the Hinge Cover](#)).
3. Remove the keyboard (see [Removing the Keyboard](#)).
4. Remove the display assembly (see [Removing the Display Assembly](#)).
5. Remove the display bezel (see [Removing the Display Bezel](#)).
6. Remove the eight M2 x 3-mm screws (four on each side of the display panel) from around the display panel.
7. Lift the top of the display panel, then rotate the camera/microphone connector latch upward to release the camera/microphone cable.
8. Lift the display panel out of the display cover.

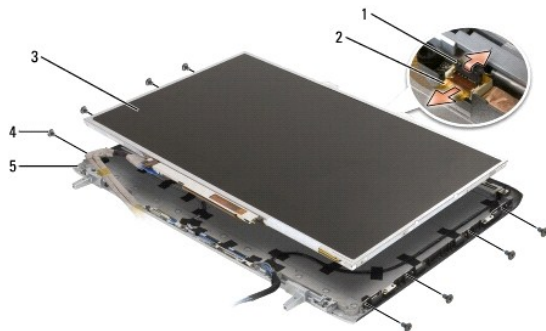

1	camera/microphone connector latch	2	camera/microphone cable connector
3	display panel	4	M2 x 3-mm screws (8)
5	display cover		

9. Use the pull tab to disconnect the bottom flex-cable connector from the inverter connector.
10. Press inward on the metal clamps on both sides of the top flex-cable connector and gently pull to disconnect the top flex-cable connector from the display locking connector.

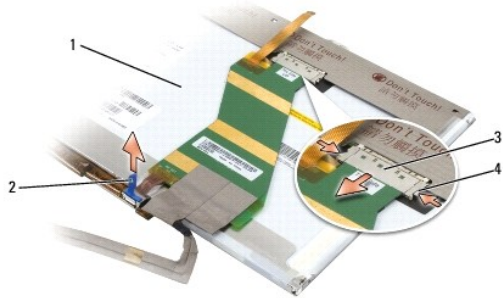

1	back of display panel	2	pull tab on bottom flex-cable connector
3	top flex-cable connector	4	metal clamps (2)

Replacing the Display Panel

⚠ CAUTION: Before you begin the following procedure, follow the safety instructions in the *Product Information Guide*.

1. Follow the instructions in [Before You Begin](#).
2. Connect the top flex-cable connector to the display connector.
3. Connect the bottom flex-cable connector to the inverter connector.
4. Align the screw holes on the display panel with the corresponding screw holes and guide pins on the top cover.
5. With the top of the display panel raised slightly, slide the camera/microphone cable into the camera/microphone connector, then rotate the camera/microphone connector latch downward to secure the cable.
6. Gently lower the display panel into place.
7. Replace the eight M2 x 3-mm screws (four on each side of the display panel) to secure the display panel to the display cover.
8. Replace the display bezel (see [Replacing the Display Bezel](#)).
9. Replace the display assembly (see [Replacing the Display Assembly](#)).
10. Replace the keyboard (see [Replacing the Keyboard](#)).
11. Replace the hinge cover (see [Replacing the Hinge Cover](#)).

Display Latch

Removing the Display Latch

⚠ CAUTION: Before you begin the following procedure, follow the safety instructions in the *Product Information Guide*.

1. Follow the instructions in [Before You Begin](#).
2. Remove the hinge cover (see [Removing the Hinge Cover](#)).
3. Remove the keyboard (see [Removing the Keyboard](#)).
4. Remove the display assembly (see [Removing the Display Assembly](#)).
5. Remove the display bezel (see [Removing the Display Bezel](#)).

- Using your fingers, carefully pull or flex the left side of display latch toward the bottom of the display cover (toward the hinges), and then lift to separate the latch from the cover.

NOTICE: The display latch spring may be covered by a plastic sleeve. Neither the spring nor the plastic sleeve are secured to the latch assembly and can be easily misplaced. When removing the display latch, place the spring and plastic sleeve in a secure location.

- Remove the display latch spring and set it aside.

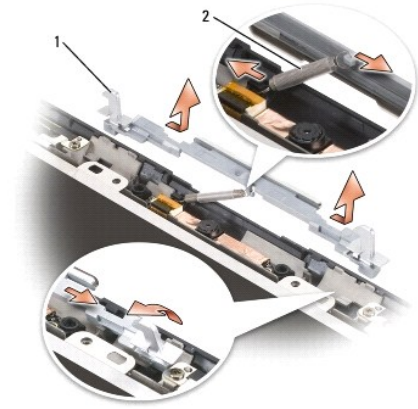

1	display latch	2	display latch spring
---	---------------	---	----------------------

Replacing the Display Latch

CAUTION: Before you begin the following procedure, follow the safety instructions in the *Product Information Guide*.

- Follow the instructions in [Before You Begin](#).
- Slide the latch spring into the plastic sleeve, if present, then connect the spring to the display latch and display cover.
- Align the notches on the display latch with the tabs on the display cover, then gently press the display latch into place.

NOTE: If necessary, carefully pull or flex each end of the display latch toward the bottom of the display cover, and then press the latch into place.

- Replace the display bezel (see [Replacing the Display Bezel](#)).
- Replace the display assembly (see [Replacing the Display Assembly](#)).
- Replace the keyboard (see [Replacing the Keyboard](#)).
- Replace the hinge cover (see [Replacing the Hinge Cover](#)).

Camera and Microphone Assembly

Removing the Camera and Microphone Assembly

CAUTION: Before you begin the following procedure, follow the safety instructions in the *Product Information Guide*.

- Follow the instructions in [Before You Begin](#).
- Remove the hinge cover (see [Removing the Hinge Cover](#)).
- Remove the keyboard (see [Removing the Keyboard](#)).

4. Remove the display assembly (see [Removing the Display Assembly](#)).
5. Remove the display bezel (see [Removing the Display Bezel](#)).
6. Remove the display panel (see [Removing the Display Panel](#)).
7. Remove the two M2 x 3-mm screws that secure the camera and microphone assembly to the display cover.
8. Lift the camera and microphone assembly out of the display cover.

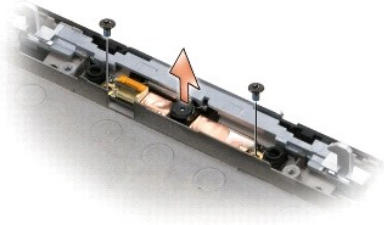

Replacing the Camera and Microphone Assembly

⚠ CAUTION: Before you begin the following procedure, follow the safety instructions in the *Product Information Guide*.

1. Follow the instructions in [Before You Begin](#).
2. Align the screw holes in the camera and microphone assembly with the screw holes in the display cover, then lower the assembly into place.
3. Replace the two M2 x 3-mm screws and secure the camera and microphone assembly to the display cover.
4. Replace the display panel (see [Replacing the Display Panel](#)).
5. Replace the display bezel (see [Replacing the Display Bezel](#)).
6. Replace the display assembly (see [Replacing the Display Assembly](#)).
7. Replace the keyboard (see [Replacing the Keyboard](#)).
8. Replace the hinge cover (see [Replacing the Hinge Cover](#)).

[Back to Contents Page](#)

Fan

Dell™ Vostro™ 1500 and Inspiron™ 1520/1521 Service Manual

- [Removing the Fan](#)
- [Replacing the Fan](#)

Removing the Fan

⚠ CAUTION: Before you begin the following procedure, follow the safety instructions in the *Product Information Guide*.

1. Follow the instructions in [Before You Begin](#).
2. Remove the optical drive (see [Removing the Optical Drive](#)).
3. Remove the hard drive (see [Removing the Hard Drive](#)).
4. Remove the hinge cover (see [Removing the Hinge Cover](#)).
5. Remove the keyboard (see [Removing the Keyboard](#)).
6. Remove the display assembly (see [Removing the Display Assembly](#)).
7. Remove the internal card with Bluetooth wireless technology, if installed (see [Removing the Bluetooth Card](#)).
8. Remove the palm rest (see [Removing the Palm Rest](#)).
9. Remove the graphics card assembly, if installed (see [Removing the Graphics Card Assembly](#)).
10. Remove the processor thermal-cooling assembly (see [Removing the Processor Thermal-Cooling Assembly](#)).
11. Disconnect the fan connector from the system board connector.
12. Remove the two M2.5 x 5-mm screws that secure the fan to the base of the computer.
13. Remove the fan.



1	M2.5 x 5-mm screws (2)	2	fan
3	fan connector		

Replacing the Fan

⚠ CAUTION: Before you begin the following procedure, follow the safety instructions in the *Product Information Guide*.

1. Align the screw holes on the fan with the holes on the base of the computer.
 2. Replace the two M2.5 x 5-mm screws to secure the fan to the base of the computer.
 3. Connect the fan connector to the system board connector.
 4. Replace the processor thermal-cooling assembly (see [Replacing the Processor Thermal-Cooling Assembly](#)).
 5. Replace the graphics card assembly, if applicable (see [Replacing the Graphics Card Assembly](#)).
 6. Replace the palm rest (see [Replacing the Palm Rest](#)).
 7. Replace the internal card with Bluetooth wireless technology, if applicable (see [Replacing the Bluetooth Card](#)).
 8. Replace the display assembly (see [Replacing the Display Assembly](#)).
 9. Replace the keyboard (see [Replacing the Keyboard](#)).
 10. Replace the hinge cover (see [Replacing the Hinge Cover](#)).
 11. Replace the hard drive (see [Replacing the Hard Drive](#)).
 12. Replace the optical drive (see [Replacing the Optical Drive](#)).
-

[Back to Contents Page](#)

[Back to Contents Page](#)

Graphics Card Assembly

Dell™ Vostro™ 1500 and Inspiron™ 1520/1521 Service Manual

- [Removing the Graphics Card Assembly](#)
- [Replacing the Graphics Card Assembly](#)

 **NOTE:** The graphics card assembly is available as an option on the Vostro 1500 and Inspiron 1520 only.

Removing the Graphics Card Assembly

 **CAUTION:** Before you begin the following procedure, follow the safety instructions in the *Product Information Guide*.

1. Follow the instructions in [Before You Begin](#).
2. Remove the optical drive (see [Removing the Optical Drive](#)).
3. Remove the hard drive (see [Removing the Hard Drive](#)).
4. Remove the hinge cover (see [Removing the Hinge Cover](#)).
5. Remove the keyboard (see [Removing the Keyboard](#)).
6. Remove the display assembly (see [Removing the Display Assembly](#)).
7. Remove the internal card with Bluetooth wireless technology, if installed (see [Removing the Bluetooth Card](#)).
8. Remove the palm rest (see [Removing the Palm Rest](#)).
9. In sequential order, loosen the three captive screws that secure the graphics card assembly to the system board, then carefully lift the assembly out of the computer.

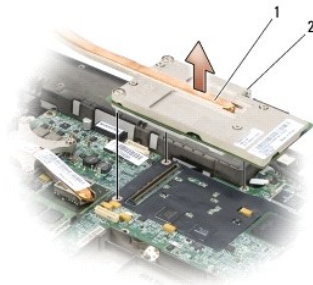

1	graphics card assembly	2	captive screws (3)
---	------------------------	---	--------------------

Replacing the Graphics Card Assembly

 **CAUTION:** Before you begin the following procedure, follow the safety instructions in the *Product Information Guide*.

1. Align the three captive screws on the graphics card assembly with the screw holes on the system board.
2. In sequential order, tighten the three captive screws to secure the graphics card assembly to the system board.
3. Replace the palm rest (see [Replacing the Palm Rest](#)).
4. Replace the internal card with Bluetooth wireless technology, if applicable (see [Replacing the Bluetooth Card](#)).
5. Replace the display assembly (see [Replacing the Display Assembly](#)).

6. Replace the keyboard (see [Replacing the Keyboard](#)).
 7. Replace the hinge cover (see [Replacing the Hinge Cover](#)).
 8. Replace the hard drive (see [Replacing the Hard Drive](#)).
 9. Replace the optical drive (see [Replacing the Optical Drive](#)).
-

[Back to Contents Page](#)

Hard Drive

Dell™ Vostro™ 1500 and Inspiron™ 1520/1521 Service Manual

- [Removing the Hard Drive](#)
- [Replacing the Hard Drive](#)

 **NOTE:** Dell does not guarantee compatibility or provide support for hard drives obtained from sources other than Dell.

Removing the Hard Drive

 **CAUTION:** Before you begin any of the procedures in this section, follow the safety instructions in the *Product Information Guide*.

 **CAUTION:** Do not touch the metal housing of the hard drive if you remove the hard drive from the computer while the drive is hot.

 **NOTICE:** To prevent data loss, turn off your computer before removing the hard drive. Do not remove the hard drive while the computer is on or in Sleep state.

 **NOTICE:** Hard drives are extremely fragile. Exercise care when handling the hard drive.

1. Follow the procedures in [Before You Begin](#).
2. Turn the computer over.
3. Remove the four M3 x 3-mm screws that secure the hard drive.

 **NOTICE:** When the hard drive is not in the computer, store the drive in protective antistatic packaging.

4. Slide the hard drive out of the computer.

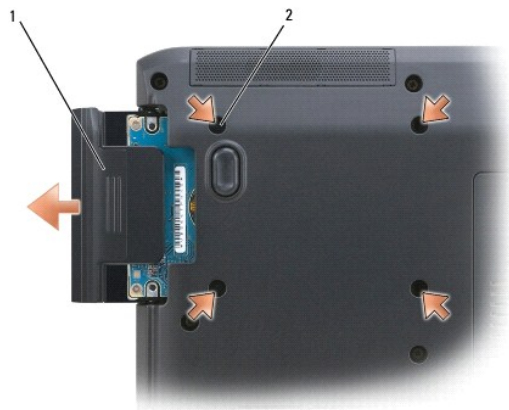

1	hard drive	2	M3 x 3-mm screws (4)
---	------------	---	----------------------

5. Remove the two M3 x 3-mm screws from each side of the hard drive bezel, then pull to separate the bezel from the hard drive.

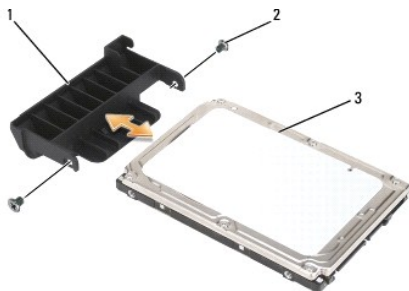

1	hard drive bezel	2	M3 x 3-mm screws (2)
3	hard drive		

Replacing the Hard Drive

 **CAUTION:** Before you begin any of the procedures in this section, follow the safety instructions in the *Product Information Guide*.

 **NOTICE:** Hard drives are extremely fragile. Exercise care when handling the hard drive.

1. Slide the hard drive bezel onto the hard drive, then tighten the two M3 x 3-mm screws to secure the bezel to the drive.

 **NOTICE:** Use firm and even pressure to slide the hard drive into place. Excessive force may result in damage to the connector.

2. Slide the hard drive into the hard drive bay until the drive is fully seated.
 3. Replace the four M3 x 3-mm screws to secure the hard drive.
 4. Install the operating system for your computer, as needed (see "Restoring Your Operating System" in your *Owner's Manual*).
 5. Install the drivers and utilities for your computer, as needed (see "Reinstalling Drivers and Utilities" in your *Owner's Manual*).
-

[Back to Contents Page](#)

Hinge Cover

Dell™ Vostro™ 1500 and Inspiron™ 1520/1521 Service Manual

- [Removing the Hinge Cover](#)
- [Replacing the Hinge Cover](#)

Removing the Hinge Cover

⚠ CAUTION: Before you begin any of the procedures in this section, follow the safety instructions in the *Product Information Guide*.

➡ NOTICE: The hinge cover is fragile and can be damaged if extreme force is used. Exercise care when removing the hinge cover.

1. Follow the procedures in [Before You Begin](#).
2. Open the display all the way so that it rests flat on your work surface.

➡ NOTICE: To avoid damage to the hinge cover, do not lift the cover on both sides simultaneously.

3. Insert a plastic scribe into the indent to lift the hinge cover on the right side.
4. Moving from right to left, ease the hinge cover up, then remove it and set it aside.

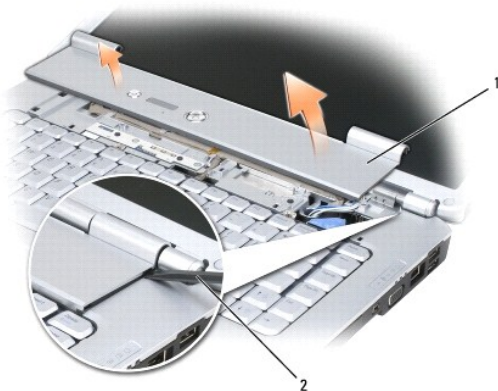

1	hinge cover	2	plastic scribe
---	-------------	---	----------------

Replacing the Hinge Cover

⚠ CAUTION: Before you begin any of the procedures in this section, follow the safety instructions in the *Product Information Guide*.

➡ NOTICE: The hinge cover is fragile and can be damaged if extreme force is used. Exercise care when replacing the hinge cover.

1. Follow the procedures in [Before You Begin](#).
2. Align the two tabs along the left edge of the hinge cover with the corresponding notches in the computer.
3. Moving from left to right, press down until the hinge cover snaps into place.

[Back to Contents Page](#)

Keyboard

Dell™ Vostro™ 1500 and Inspiron™ 1520/1521 Service Manual

- [Removing the Keyboard](#)
- [Replacing the Keyboard](#)

For more information about the keyboard, see "Using the Keyboard and Touchpad" in your *Owner's Manual*.

Removing the Keyboard

⚠ CAUTION: Before you begin any of the procedures in this section, follow the safety instructions in the **Product Information Guide**.

1. Follow the procedures in [Before You Begin](#).
2. Remove the hinge cover (see [Removing the Hinge Cover](#)).
3. Remove the two M2.5 x 5-mm screws at the top of the keyboard.

👉 NOTICE: The key caps on the keyboard are fragile, easily dislodged, and time-consuming to replace. Exercise care when removing and handling the keyboard.

4. Lift the keyboard and hold it up and slightly forward to access to the keyboard connector.
5. Rotate the keyboard connector latch upward to release the keyboard cable.
6. Slide the keyboard cable out of the keyboard connector.

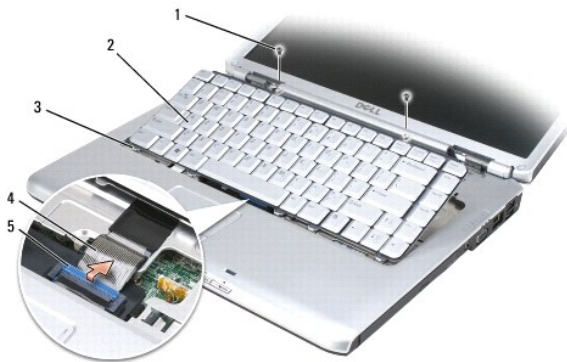

1	M2.5 x 5-mm screws (2)	2	keyboard
3	tabs (5)	4	keyboard cable
5	keyboard connector latch		

Replacing the Keyboard

⚠ CAUTION: Before you begin any of the procedures in this section, follow the safety instructions in the **Product Information Guide**.

1. Follow the procedures in [Before You Begin](#).

👉 NOTICE: The key caps on the keyboard are fragile, easily dislodged, and time-consuming to replace. Exercise care when removing and handling the keyboard.

2. Slide the keyboard cable into the keyboard connector.

3. Rotate the keyboard connector latch downward to secure the cable.
 4. Hook the tabs along the front edge of the keyboard beneath the front- inside edge of the palmrest.
 5. Press on the right edge near the top to snap the keyboard into place.
 6. Replace the two M2.5 x 5-mm screws at the top of the keyboard.
-

[Back to Contents Page](#)

Battery Latch Assembly

Dell™ Vostro™ 1500 and Inspiron™ 1520/1521 Service Manual

- [Removing the Battery Latch Assembly](#)
- [Replacing the Battery Latch Assembly](#)

Removing the Battery Latch Assembly

⚠ CAUTION: Before you begin the following procedure, follow the safety instructions in the *Product Information Guide*.

1. Follow the instructions in [Before You Begin](#).
2. Remove the computer base (see [Removing the Computer Base](#)).
3. Remove the screw from the battery latch assembly.
4. Use a plastic scribe to push the battery release button through the hole in the battery latch assembly.

➡ NOTICE: The battery latch spring is not secured to the latch assembly and can be easily misplaced. When removing the battery latch assembly, place the spring in a secure location until the latch is ready to be reinstalled.

5. Remove battery latch assembly.

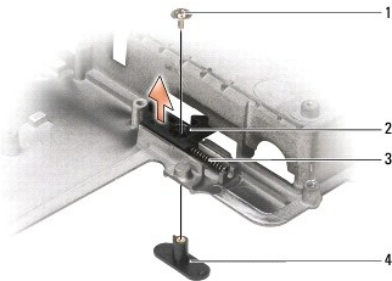

1	screw	2	battery latch assembly
3	spring	4	battery release button

➡ NOTICE: Before you remove the battery release button, observe the orientation of the button to ensure proper installation when the button is replaced.

Replacing the Battery Latch Assembly

⚠ CAUTION: Before you begin the following procedure, follow the safety instructions in the *Product Information Guide*.

➡ NOTICE: Ensure the battery latch assembly is properly oriented. The indent for the screw should face up when installing the assembly.

1. Ensure that the battery latch spring is properly mounted on the guide post of the battery latch assembly.
2. Align the guide post on the battery latch assembly with the slot on the base of the computer, then lower the latch assembly into place.

➡ NOTICE: The battery release button is keyed to ensure proper. If you feel resistance, check the alignment of the release button.

3. Align the battery release button with the hole in the battery latch assembly, then press the button into place.
 4. Replace the computer base (see [Replacing the Computer Base](#)).
-

[Back to Contents Page](#)

[Back to Contents Page](#)

Memory

Dell™ Vostro™ 1500 and Inspiron™ 1520/1521 Service Manual

- [Removing a Memory Module](#)
- [Replacing a Memory Module](#)

Your computer has two user-accessible SODIMM sockets, one accessed from beneath the keyboard (DIMM A), and the other accessed from the bottom of the computer (DIMM B).

You can increase your computer memory by installing memory modules on the system board. See "Specifications" in your *Owner's Manual* for information on the memory supported by your computer. Install only memory modules that are intended for your computer.

- ➔ **NOTICE:** If your computer has only one memory module, install the memory module in the connector labeled "DIMMA."
- ➔ **NOTICE:** If you need to install memory modules in two connectors, install a memory module in the connector labeled "DIMMA" before you install a module in the connector labeled "DIMMB."
- 🔧 **NOTE:** Memory modules purchased from Dell are covered under your computer warranty.

Removing a Memory Module

- ⚠ **CAUTION:** Before you begin any of the procedures in this section, follow the safety instructions in the *Product Information Guide*.

DIMM A Memory Module

The DIMM A memory module is located under the keyboard.

1. Follow the procedures in [Before You Begin](#).
2. Remove the hinge cover (see [Removing the Hinge Cover](#)).
3. Remove the keyboard (see [Removing the Keyboard](#)).

- 🔧 **NOTE:** It is not necessary to disconnect the keyboard cable from the memory module cover.

4. Lift the memory module cover but do not remove it.

- ➔ **NOTICE:** To prevent damage to the memory module connector, do not use tools to spread the memory module securing clips.

5. Use your fingertips to carefully spread apart the securing clips on each end of the memory module connector until the module pops up.
6. Remove the module from the connector.

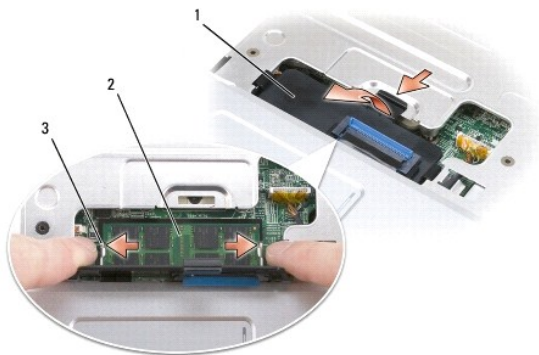

1	memory module cover	2	memory module (DIMM A)
3	securing clips (2)		

DIMM B Memory Module

The DIMM B memory module is located under the memory module cover on the bottom of the computer.

1. Follow the procedures in [Before You Begin](#).
2. Turn the computer over.
3. Loosen the captive screw on the memory module cover, then remove the cover and set it aside.

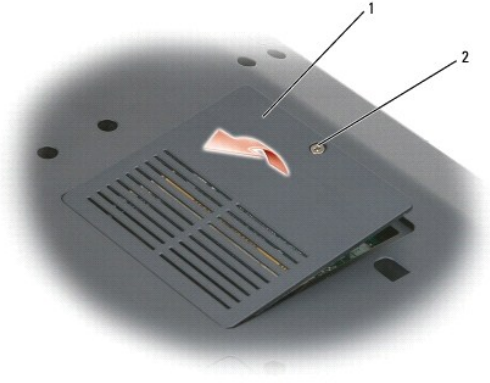

1	memory module cover	2	captive screw
---	---------------------	---	---------------

NOTICE: To prevent damage to the memory module connector, do not use tools to spread the memory module securing clips.

4. Use your fingertips to carefully spread apart the securing clips on each end of the memory module connector until the memory module pops up.
5. Remove the memory module from the connector.

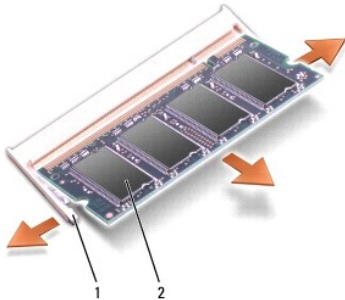

1	securing clips (2)	2	memory module
---	--------------------	---	---------------

Replacing a Memory Module

CAUTION: Before you begin any of the procedures in this section, follow the safety instructions in the *Product Information Guide*.

DIMM A Memory Module

The DIMM A memory module is located under the keyboard.

1. Follow the procedures in [Before You Begin](#).
2. Align the notch in the memory module edge connector with the tab in the connector slot.
3. Slide the memory module firmly into the slot at a 45-degree angle, and rotate the module down until it clicks into place. If you do not feel the click,

remove the module and reinstall it.

NOTE: If the memory module is not installed properly, the computer may not boot. No error message indicates this failure.

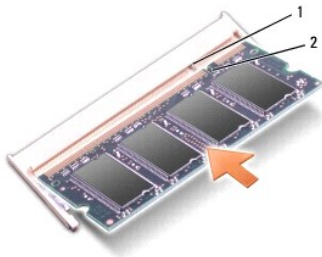

1	tab	2	notch
---	-----	---	-------

4. Replace the memory module cover.
5. Replace the keyboard (see [Replacing the Keyboard](#)).
6. Replace the hinge cover (see [Replacing the Hinge Cover](#)).
7. Insert the battery into the battery bay, or connect the AC adapter to your computer and an electrical outlet.
8. Turn on the computer.

As the computer boots, it detects the additional memory and automatically updates the system configuration information.

To confirm the amount of memory installed in the computer, click **Start** → **Help and Support** → **Dell System Information**.

DIMM B Memory Module

The DIMM B memory module is located under the memory module cover on the bottom of the computer.

1. Follow the procedures in [Before You Begin](#).
2. Turn the computer over.
3. Loosen the captive screw on the memory module cover, then remove the cover and set it aside.

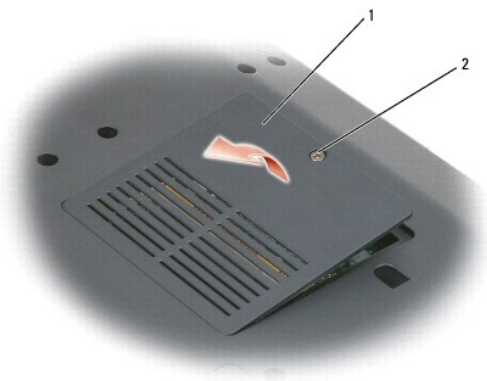

1	memory module cover	2	captive screw
---	---------------------	---	---------------

4. Align the notch in the module edge connector with the tab in the connector slot.
5. Slide the module firmly into the slot at a 45-degree angle, and rotate the module down until it clicks into place. If you do not feel the click, remove the module and reinstall it.

NOTE: If the memory module is not installed properly, the computer may not boot. No error message indicates this failure.

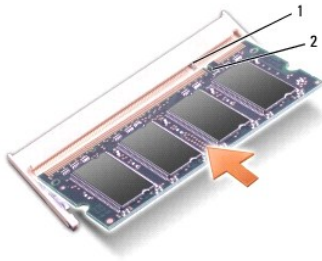

1	tab	2	notch
---	-----	---	-------

➡ **NOTICE:** If the cover is difficult to close, remove the module and reinstall it. Forcing the cover to close may damage your computer.

6. Replace the memory module cover and tighten the screw.
7. Insert the battery into the battery bay, or connect the AC adapter to your computer and an electrical outlet.
8. Turn on the computer.

As the computer boots, it detects the additional memory and automatically updates the system configuration information.

To confirm the amount of memory installed in the computer, click **Start** → **Help and Support** → **Dell System Information**.

[Back to Contents Page](#)

[Back to Contents Page](#)

Wireless Mini Cards

Dell™ Vostro™ 1500 and Inspiron™ 1520/1521 Service Manual

- [Removing a Mini Card](#)
- [Replacing a Mini Card](#)

⚠ CAUTION: Before you begin any of the procedures in this section, follow the safety instructions in the *Product Information Guide*.

If you ordered a wireless Mini Card with your computer, the card is already installed. Your computer supports three types of wireless Mini Cards:

- 1 Wireless Local Area Network (WLAN)
 - 1 Mobile Broadband or Wireless Wide Area Network (WWAN)
 - 1 Wireless Personal Area Network (WPAN)
-

Removing a Mini Card

WLAN Card

1. Follow the procedures in [Before You Begin](#).
2. Turn the computer over.
3. Loosen the two captive screws on the Mini Card compartment cover, then remove the cover and set it aside.



1	captive screws (2)	2	cover
---	--------------------	---	-------

4. Disconnect the antenna cables from the WLAN card.



1	antenna cable connectors (2)	2	WLAN card
---	------------------------------	---	-----------

5. Release the WLAN card by pushing the metal securing tabs toward the back of the computer until the card pops up slightly.
6. Lift the WLAN card out of its system board connector.



1	metal securing tabs (2)	2	WLAN card
---	-------------------------	---	-----------

Mobile Broadband or WWAN Card

 **NOTE:** WWAN is also available on an ExpressCard (see [ExpressCards](#)).

1. Follow the procedures in [Before You Begin](#).
2. Turn the computer over.
3. Loosen the two captive screws on the Mini Card compartment cover, then remove the cover and set it aside.



1	captive screws (2)	2	cover
---	--------------------	---	-------

4. Disconnect the two antenna cables from the WWAN card.



1	antenna cable connectors (2)	2	WWAN card
---	------------------------------	---	-----------

5. Release the WWAN card by pushing the metal securing tabs toward the back of the computer until the card pops up slightly.

6. Lift the WWAN card out of its system board connector.



1	metal securing tabs (2)	2	WWAN card
---	-------------------------	---	-----------

WPAN Card

1. Follow the procedures in [Before You Begin](#).
2. Turn the computer over.
3. Loosen the two captive screws on the Mini Card compartment cover, then remove the cover and set it aside.



1	captive screws (2)	2	cover
---	--------------------	---	-------

4. Disconnect the blue antenna cable from the WPAN card.



1	WPAN card	2	antenna cable connector
---	-----------	---	-------------------------

5. Release the WPAN card by pushing the metal securing tabs toward the back of the computer until the card pops up slightly.
6. Lift the WPAN card out of its system board connector.



1	WLAN card	2	metal securing tabs (2)
---	-----------	---	-------------------------

Replacing a Mini Card

WLAN Card

- ➔ **NOTICE:** The connectors are keyed to ensure correct insertion. If you feel resistance, check the connectors on the card and on the system board, and realign the card.
- ➔ **NOTICE:** To avoid damage to the WLAN card, never place cables under the card.

1. Insert the WLAN card connector at a 45-degree angle into the system board connector labeled "WLAN".
2. Press the other end of the WLAN card down into the securing tabs until the card clicks into place.
3. Connect the appropriate antenna cables to the WLAN card you are installing:

If the WLAN card has two triangles on the label (white and black), connect the white antenna cable to the connector labeled "main" (white triangle), and connect the black antenna cable to the connector labeled "aux" (black triangle).

If the WLAN card has three triangles on the label (white, black, and gray), connect the white antenna cable to the white triangle, connect the black antenna cable to the black triangle, and connect the gray antenna cable to the gray triangle.
4. Secure unused antenna cables in the protective mylar sleeve.
5. Replace the cover and tighten the captive screws.

Mobile Broadband or WWAN Card

- ➔ **NOTICE:** The connectors are keyed to ensure correct insertion. If you feel resistance, check the connectors on the card and on the system board, and realign the card.
- ➔ **NOTICE:** To avoid damage to the WWAN card, never place cables under the card.

1. Insert the WWAN card connector at a 45-degree angle into the system board connector labeled "WWAN".
2. Press the other end of the WWAN card down into the securing tabs until the card clicks into place.
3. Connect the black antenna cable with a gray stripe to the connector labeled "aux" (black triangle) and connect the white antenna cable with a gray stripe to the connector labeled "main" (white triangle).
4. Secure unused antenna cables in the protective mylar sleeve.
5. Replace the cover and tighten the captive screws.

WPAN Card

➡ **NOTICE:** The connectors are keyed to ensure correct insertion. If you feel resistance, check the connectors on the card and on the system board, and realign the card.

➡ **NOTICE:** To avoid damage to the WPAN card, never place cables under the card.

1. Insert the WPAN card connector at a 45-degree angle into the system board connector labeled "WPAN".
2. Press the other end of the WPAN card down into the securing tabs until the card clicks into place.
3. Connect the blue antenna cable to the WPAN card.
4. Secure unused antenna cables in the protective mylar sleeve.
5. Replace the cover and tighten the captive screws.

[Back to Contents Page](#)

Modem

Dell™ Vostro™ 1500 and Inspiron™ 1520/1521 Service Manual

- [Removing the Modem](#)
- [Replacing the Modem](#)

Removing the Modem

⚠ CAUTION: Before you begin the following procedure, follow the safety instructions in the *Product Information Guide*.

1. Follow the instructions in [Before You Begin](#).
2. Remove the optical drive (see [Removing the Optical Drive](#)).
3. Remove the hard drive (see [Removing the Hard Drive](#)).
4. Remove the hinge cover (see [Removing the Hinge Cover](#)).
5. Remove the keyboard (see [Removing the Keyboard](#)).
6. Remove the display assembly (see [Removing the Display Assembly](#)).
7. Remove the internal card with Bluetooth wireless technology, if installed (see [Removing the Bluetooth Card](#)).
8. Remove the palm rest (see [Removing the Palm Rest](#)).
9. Remove the two M2 x 3-mm screws that secure the modem to the system board and the base of the computer.
10. Pull up on the pull tab to disconnect the modem from the modem connector on the system board.

🔄 NOTICE: Do not disconnect the modem cable from the system board.

11. Disconnect the modem cable from the modem.

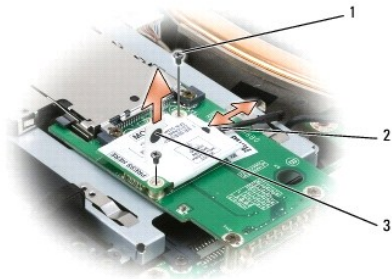

1	M2 x 3-mm screws (2)	2	modem cable
3	pull tab		

Replacing the Modem

⚠ CAUTION: Before you begin the following procedure, follow the safety instructions in the *Product Information Guide*.

🔄 NOTICE: The modem connectors are keyed to ensure correct insertion. If you feel resistance, check the connectors for proper alignment.

1. Connect the modem cable to the new modem.

2. Align the modem with the screw hole and press the modem into the connector on the system board.
 3. Replace the two M2 x 3-mm screws and secure the modem to the system board and the base of the computer.
 4. Replace the palm rest (see [Replacing the Palm Rest](#)).
 5. Replace the internal card with Bluetooth wireless technology, if applicable (see [Replacing the Bluetooth Card](#)).
 6. Replace the display assembly (see [Replacing the Display Assembly](#)).
 7. Replace the keyboard (see [Replacing the Keyboard](#)).
 8. Replace the hinge cover (see [Replacing the Hinge Cover](#)).
 9. Replace the hard drive (see [Replacing the Hard Drive](#)).
 10. Replace the optical drive (see [Replacing the Optical Drive](#)).
-

[Back to Contents Page](#)

Optical Drive

Dell™ Vostro™ 1500 and Inspiron™ 1520/1521 Service Manual

- [Removing the Optical Drive](#)
- [Replacing the Optical Drive](#)

Removing the Optical Drive

⚠ CAUTION: Before you begin any of the procedures in this section, follow the safety instructions in the *Product Information Guide*.

1. Follow the procedures in [Before You Begin](#).
2. Turn the computer over.
3. Remove the device security screw, if installed.
4. Using a plastic scribe, push the notch to release the optical drive from the bay.
5. Slide the optical drive out of the bay.



1	optical drive	2	notch
3	device security screw		

Replacing the Optical Drive

⚠ CAUTION: Before you begin any of the procedures in this section, follow the safety instructions in the *Product Information Guide*.

1. Follow the procedures in [Before You Begin](#).
2. Slide the optical drive into the bay.
3. Turn the computer over.
4. Replace and tighten the device security screw, as needed.

Palm Rest

Dell™ Vostro™ 1500 and Inspiron™ 1520/1521 Service Manual

- [Removing the Palm Rest](#)
- [Replacing the Palm Rest](#)

Removing the Palm Rest

⚠ CAUTION: Before you begin the following procedure, follow the safety instructions in the *Product Information Guide*.

1. Follow the instructions in [Before You Begin](#).
2. Remove the optical drive (see [Removing the Optical Drive](#)).
3. Remove the hard drive (see [Removing the Hard Drive](#)).
4. Remove the hinge cover (see [Removing the Hinge Cover](#)).
5. Remove the keyboard (see [Removing the Keyboard](#)).
6. Remove the display assembly (see [Removing the Display Assembly](#)).
7. Remove the internal card with Bluetooth wireless technology, if installed (see [Removing the Bluetooth Card](#)).

🔧 NOTE: It is not necessary to remove the Bluetooth cable connector from the system board connector.

8. Remove the eleven M2.5 x 8-mm screws from the bottom of the computer.

🔧 NOTE: The screw locations may vary slightly from the image shown below.



9. Turn the computer over and remove the four M2 x 3-mm screws that secure the top of the palm rest.

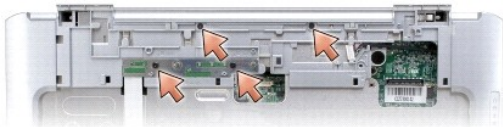

10. Disconnect the touch pad connector from the system board.

👉 NOTICE: Do not use force to separate the palm rest from the computer. If you encounter resistance, gently *flex* or apply pressure to the palm rest, or move along the edge, working away from the area of resistance, until the palm rest is free.

11. Moving from left to right, carefully lift the palm rest along the rear edge, near the hinge brackets, then gently lift the palm rest to remove it from the computer.



1	palm rest	2	computer base
3	touch pad connector		

Replacing the Palm Rest

⚠ CAUTION: Before you begin the following procedure, follow the safety instructions in the *Product Information Guide*.

👉 NOTICE: Ensure that the touch pad cable and the cable for the Bluetooth card with wireless technology are properly routed before snapping the palm rest into place.

1. Align the palm rest with the base of the computer and gently snap it into place.
2. Connect the touch pad connector to the system board.
3. Replace the four M2 x 3-mm screws on the top of the palm rest.
4. Turn the computer over and replace the eleven M2.5 x 8-mm screws on the bottom of the computer to secure the palm rest.
5. Replace the internal card with Bluetooth wireless technology, if applicable (see [Replacing the Bluetooth Card](#)).
6. Replace the display assembly (see [Replacing the Display Assembly](#)).
7. Replace the keyboard (see [Replacing the Keyboard](#)).
8. Replace the hinge cover (see [Replacing the Hinge Cover](#)).
9. Replace the hard drive (see [Replacing the Hard Drive](#)).
10. Replace the optical drive (see [Replacing the Optical Drive](#)).

[Back to Contents Page](#)

[Back to Contents Page](#)

ExpressCards

Dell™ Vostro™ 1500 and Inspiron™ 1520/1521 Service Manual

- [ExpressCard Blanks](#)
- [Removing an ExpressCard or Blank](#)
- [Installing an ExpressCard or Blank](#)

ExpressCards provide wired and wireless communications, multimedia and security features. For example, you can add an ExpressCard to make wireless wide area network (WWAN) connectivity available on your computer.

ExpressCards support two form factors:

- 1 ExpressCard/34 (34 mm wide)
- 1 ExpressCard/54 (54 mm wide in an L-shape with a 34-mm connector)

The 34-mm card fits into both the 34-mm and 54-mm card slots. The 54-mm card only fits into a 54-mm card slot.

See "Specifications" in your *Owner's Manual* for information on supported ExpressCards.

 **NOTE:** An ExpressCard is not a bootable device.

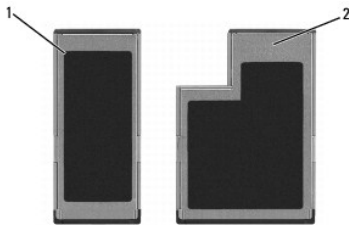

1	ExpressCard/34	2	ExpressCard/54
---	----------------	---	----------------

ExpressCard Blanks

Your computer shipped with a plastic blank installed in the ExpressCard slot. Blanks protect unused slots from dust and other particles. Save the blank for use when no ExpressCard is installed in the slot.

 **NOTE:** Blanks from other computers may not fit your computer.

Removing an ExpressCard or Blank

 **CAUTION:** Before you begin any of the procedures in this section, follow the safety instructions in the *Product Information Guide*.

Press the release button and remove the card or blank. For some release buttons, you must press the button twice, once to pop the latch out, and then a second time to pop the card out.

Save a blank to use when no ExpressCard is installed in a slot. Blanks protect unused slots from dust and other particles.

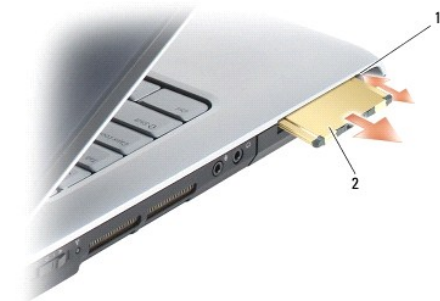

Installing an ExpressCard or Blank

⚠ CAUTION: Before you begin any of the procedures in this section, follow the safety instructions in the *Product Information Guide*.

You can install an ExpressCard in the computer while the computer is running. The computer automatically detects the card.

ExpressCards are generally marked with a symbol (such as a triangle or an arrow) or a label to indicate which end to insert into the slot. The cards are keyed to prevent incorrect insertion. If card orientation is not clear, see the documentation that came with the card.

1. Hold the card with its orientation symbol pointing into the slot and the top side of the card facing up. The latch may need to be in the *in* position before you insert the card.
2. Slide the card into the slot until the card is completely seated in its connector.

If you encounter too much resistance, do not force the card. Check the card orientation and try again.

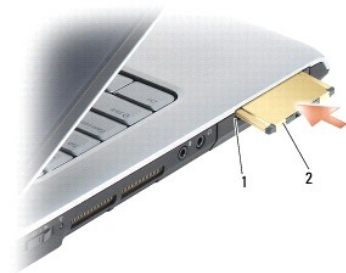

The computer recognizes the ExpressCard and automatically loads the appropriate device driver. If the configuration program tells you to load the manufacturer's drivers, use the media that came with the ExpressCard.

Pin Assignments for I/O Connectors

Dell™ Vostro™ 1500 and Inspiron™ 1520/1521 Service Manual

- [USB Connector](#)
 - [Video Connector](#)
 - [S-Video TV-Out Connector](#)
 - [1394 Connector](#)
-

USB Connector

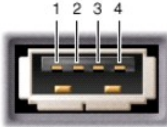

Pin	Signal
1	USB5V+
2	USBP-
3	USBP+
4	GND

Video Connector



Pin	Signal	Pin	Signal
1	CRT_R	9	5V+
2	CRT_G	10	GND
3	CRT_B	11	MONITOR_DETECT-
4	NC	12	DDC_DATA
5	GND	13	CRT_HS
6	GND	14	CRT_VS
7	GND	15	DDC_CLK
8	GND		

S-Video TV-Out Connector

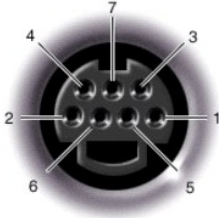

S-Video	
Pin	Signal
1	GND
2	GND
3	DLUMA-L
4	DCRMA-L

1394 Connector

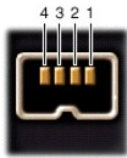

Pin	Signal
1	TPB-
2	TPB+
3	TPA-
4	TPA+

[Back to Contents Page](#)

Speaker Assembly

Dell™ Vostro™ 1500 and Inspiron™ 1520/1521 Service Manual

- [Removing the Speaker Assembly](#)
- [Replacing the Speaker Assembly](#)

Removing the Speaker Assembly

⚠ CAUTION: Before you begin the following procedure, follow the safety instructions in the *Product Information Guide*.

1. Follow the instructions in [Before You Begin](#).
2. Remove the optical drive (see [Removing the Optical Drive](#)).
3. Remove the hard drive (see [Removing the Hard Drive](#)).
4. Remove the hinge cover (see [Removing the Hinge Cover](#)).
5. Remove the keyboard (see [Removing the Keyboard](#)).
6. Remove the display assembly (see [Removing the Display Assembly](#)).
7. Remove the internal card with Bluetooth wireless technology, if installed (see [Removing the Bluetooth Card](#)).
8. Remove the palm rest (see [Removing the Palm Rest](#)).
9. Disconnect the speaker cable from the system board.
10. Remove the two M2.5 x 5-mm screws that secure the speaker assembly to the base of the computer.
11. Remove the speaker assembly.

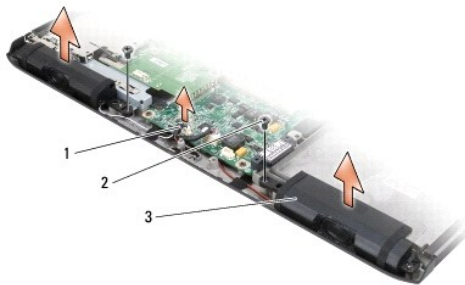

1	speaker connector	2	M2.5 x 5-mm screws (2)
3	speaker assembly		

Replacing the Speaker Assembly

⚠ CAUTION: Before you begin the following procedure, follow the safety instructions in the *Product Information Guide*.

1. Align the guide holds in the speaker assembly with the guide posts on the base of the computer, then lower the assembly into place.
2. Replace the two M2.5 x 5-mm screws to secure the speaker assembly to the base of the computer.
3. Connect the speaker cable to the system board.

4. Replace the palm rest (see [Replacing the Palm Rest](#)).
 5. Replace the internal card with Bluetooth wireless technology, if applicable (see [Replacing the Bluetooth Card](#)).
 6. Replace the display assembly (see [Replacing the Display Assembly](#)).
 7. Replace the keyboard (see [Replacing the Keyboard](#)).
 8. Replace the hinge cover (see [Replacing the Hinge Cover](#)).
 9. Replace the hard drive (see [Replacing the Hard Drive](#)).
 10. Replace the optical drive (see [Replacing the Optical Drive](#)).
-

[Back to Contents Page](#)

[Back to Contents Page](#)

System Board Assembly

Dell™ Vostro™ 1500 and Inspiron™ 1520/1521 Service Manual

- [Removing the System Board Assembly](#)
- [Replacing the System Board Assembly](#)

The system board's BIOS chip contains the Service Tag, which is also visible on a barcode label on the bottom of the computer. The replacement kit for the system board includes media that provides a utility for transferring the Service Tag to the replacement system board.

Removing the System Board Assembly

 **CAUTION:** Before you begin the following procedure, follow the safety instructions in the *Product Information Guide*.

1. Follow the instructions in [Before You Begin](#).
2. Remove the optical drive (see [Removing the Optical Drive](#)).
3. Remove the hard drive (see [Removing the Hard Drive](#)).
4. Remove all Mini-Cards (see [Removing a Mini Card](#)).
5. Remove the DIMM B memory module, if installed (see [Removing a Memory Module](#)).
6. Remove the hinge cover (see [Removing the Hinge Cover](#)).
7. Remove the keyboard (see [Removing the Keyboard](#)).
8. Remove the display assembly (see [Removing the Display Assembly](#)).
9. Remove the internal card with Bluetooth wireless technology, if installed (see [Removing the Bluetooth Card](#)).
10. Remove the palm rest (see [Removing the Palm Rest](#)).
11. Remove the DIMM A memory module (see [Removing a Memory Module](#)).
12. Remove the modem (see [Removing the Modem](#)).
13. Remove the ExpressCard cage (see [Removing the ExpressCard Cage](#)).
14. Remove the graphics card assembly, if installed (see [Removing the Graphics Card Assembly](#)).
15. Remove the processor thermal-cooling assembly (see [Removing the Processor Thermal-Cooling Assembly](#)).
16. Remove the processor (see [Removing the Processor Module](#)).
17. Remove the fan (see [Removing the Fan](#)).
18. Disconnect the cable for the Bluetooth card with wireless technology from the system board, then remove the cable and set it aside.
19. Disconnect the speaker cable from the system board.
20. Disconnect the sniffer cable/audio cable from the system board.
21. Disconnect the consumer infrared (CIR) cable from the system board.
22. Remove the twelve M2.5 x 5-mm screws from the top of the system board.

 **NOTE:** Depending on your system configuration, the number of screws shown may be greater than the number of screws present in your system.

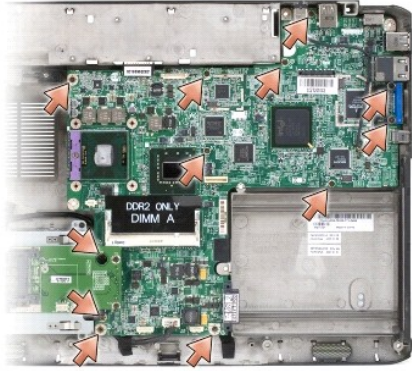

23. Lift the left side of the system board, and then carefully lift the system board out of the computer.

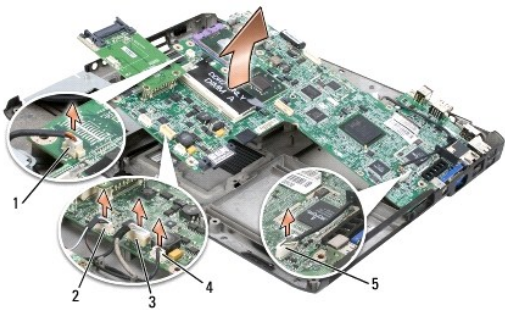

1	fan cable connector	2	speaker cable connector
3	sniffer/audio cable connector	4	CIR cable connector
5	Bluetooth cable connector		

Replacing the System Board Assembly

⚠ CAUTION: Before you begin the following procedure, follow the safety instructions in the *Product Information Guide*.

🔒 NOTICE: Ensure that any loose cables do not get caught beneath the system board.

1. Insert the right side of the system board into the base of the computer at an angle until the connectors on the system board are aligned with the holes on the base of the computer, then carefully lower the system board into place.
2. Replace the twelve M2.5 x 5-mm screws on the top of the system board.
3. Connect the consumer infrared (CIR) cable to the system board.
4. Connect the sniffer cable/audio cable to the system board.
5. Connect the speaker cable to the system board.
6. Connect one end of the cable for the Bluetooth card with wireless technology to the system board.
7. Replace the fan (see [Replacing the Fan](#)).
8. Replace the processor (see [Replacing the Processor Module](#)).
9. Replace the processor thermal-cooling assembly (see [Replacing the Processor Thermal-Cooling Assembly](#)).
10. Replace the graphics card assembly, if applicable (see [Replacing the Graphics Card Assembly](#)).
11. Replace the ExpressCard cage (see [Replacing the ExpressCard Cage](#)).

12. Replace the modem (see [Replacing the Modem](#)).
13. Replace the DIMM A memory module (see [Replacing a Memory Module](#)).
14. Replace the palm rest (see [Replacing the Palm Rest](#)).
15. Replace the internal card with Bluetooth wireless technology, if installed (see [Replacing the Bluetooth Card](#)).
16. Replace the display assembly (see [Replacing the Display Assembly](#)).
17. Replace the keyboard (see [Replacing the Keyboard](#)).
18. Replace the hinge cover (see [Replacing the Hinge Cover](#)).
19. Replace the DIMM B memory module, if installed (see [Replacing a Memory Module](#)).
20. Replace all Mini-Cards (see [Replacing a Mini Card](#)).
21. Replace the hard drive (see [Replacing the Hard Drive](#)).
22. Replace the optical drive (see [Replacing the Optical Drive](#)).

 **NOTICE:** Before turning on the computer, replace all screws and ensure that no stray screws remain inside the computer. Failure to do so may result in damage to the computer.

23. Turn on the computer.

 **NOTE:** If you use a BIOS update program CD to flash the BIOS, press <F12> before inserting the CD in order to set the computer to boot from the CD for one time only. Otherwise, you must enter the system setup program to change the default boot order.

24. Flash update the BIOS (see [Flashing the BIOS](#) for more information).
25. Enter the system setup program to update the BIOS on the new system board with the computer Service Tag.

[Back to Contents Page](#)

[Back to Contents Page](#)

Dell™ Vostro™ 1500 and Inspiron™ 1520/1521 Service Manual



NOTE: A NOTE indicates important information that helps you make better use of your computer.



NOTICE: A NOTICE indicates either potential damage to hardware or loss of data and tells you how to avoid the problem.



CAUTION: A CAUTION indicates potential for property damage, personal injury, or death.

Information in this document is subject to change without notice.
© 2007 Dell Inc. All rights reserved.

Reproduction in any manner whatsoever without the written permission of Dell Inc. is strictly forbidden.

Trademarks used in this text: *Dell*, the *DELL* logo, *Inspiron*, and *Vostro* are trademarks of Dell Inc.; *Microsoft*, *Windows*, and *Windows Vista* are either trademarks or registered trademarks of Microsoft Corporation in the United States and/or other countries.

Other trademarks and trade names may be used in this document to refer to either the entities claiming the marks and names or their products. Dell Inc. disclaims any proprietary interest in trademarks and trade names other than its own.

June 2007 Rev. A00

[Back to Contents Page](#)